



22

Vol.76

21

13



TEL : 03-5253-1111 (3944)
FAX : 03-3503-7894

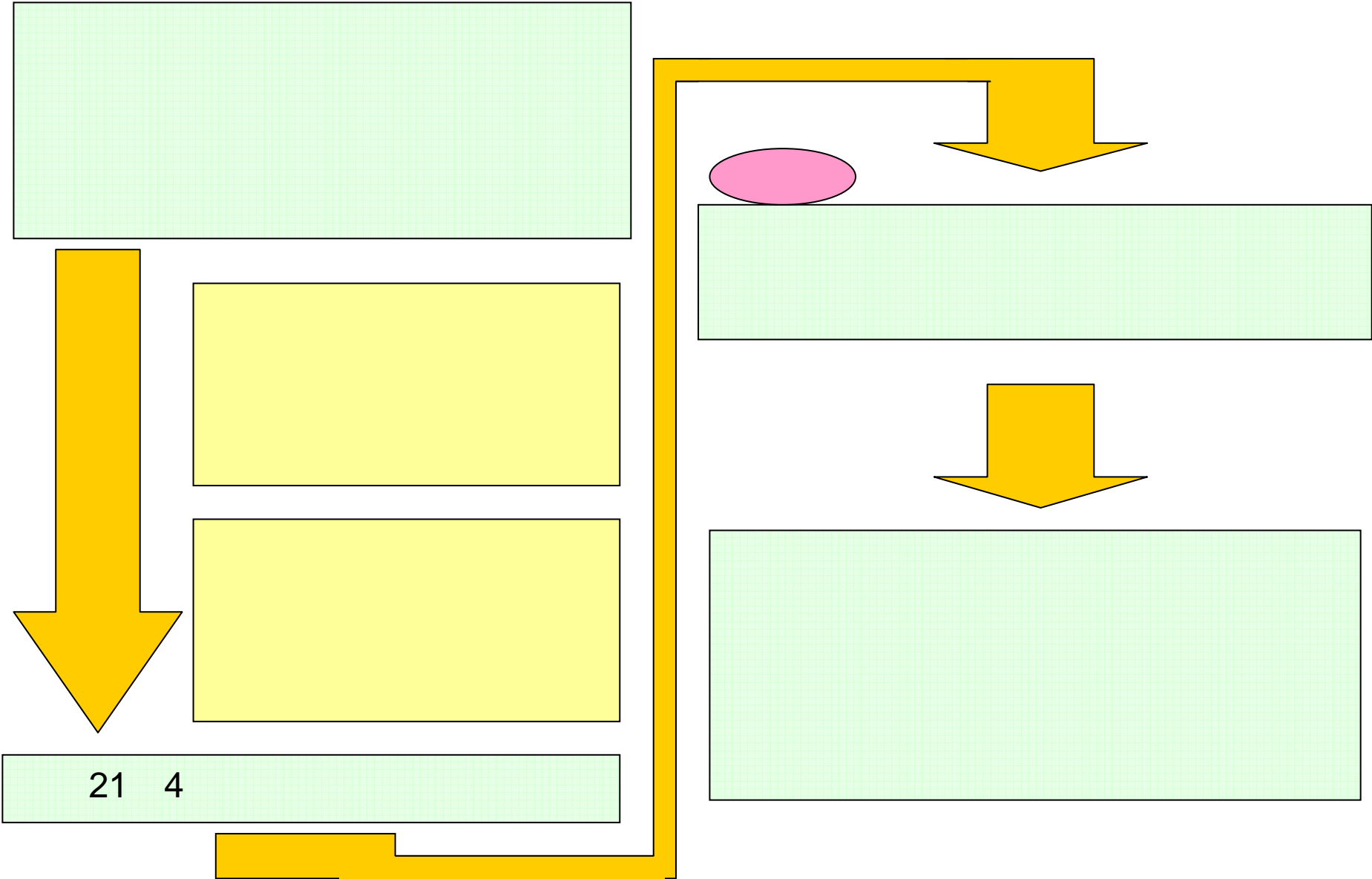
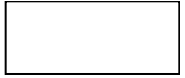

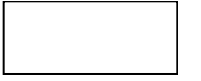

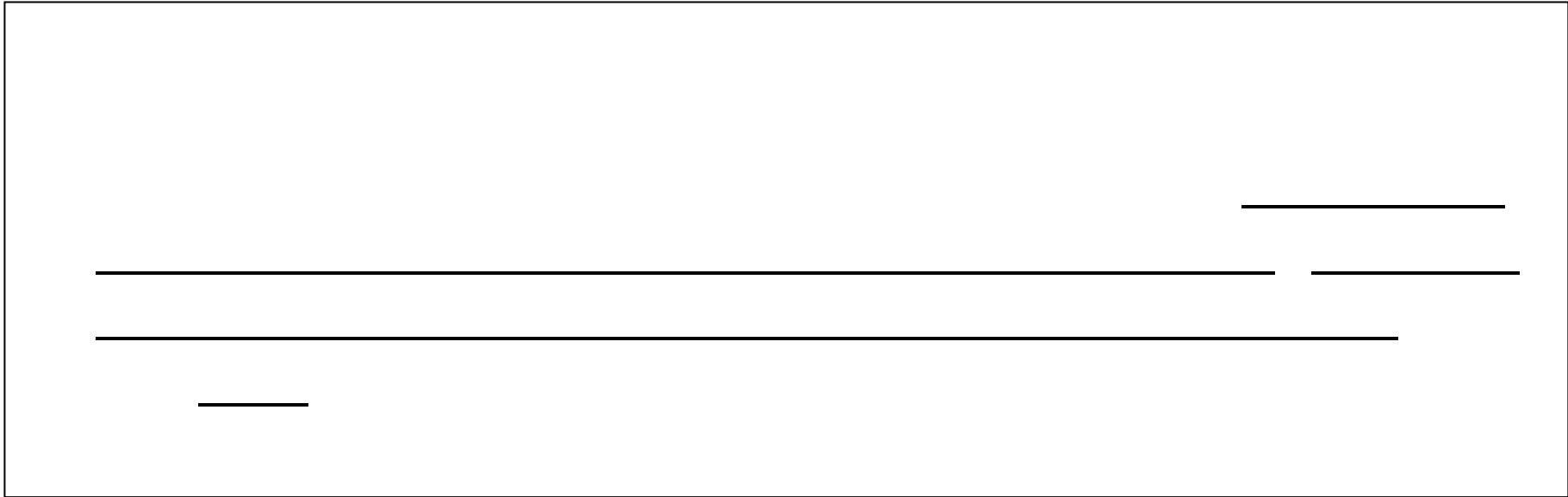
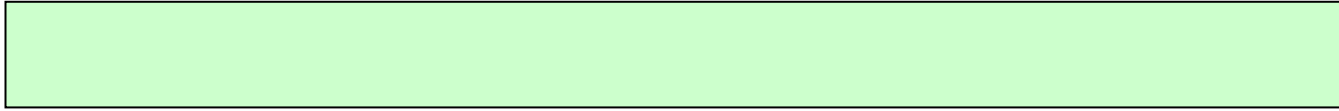

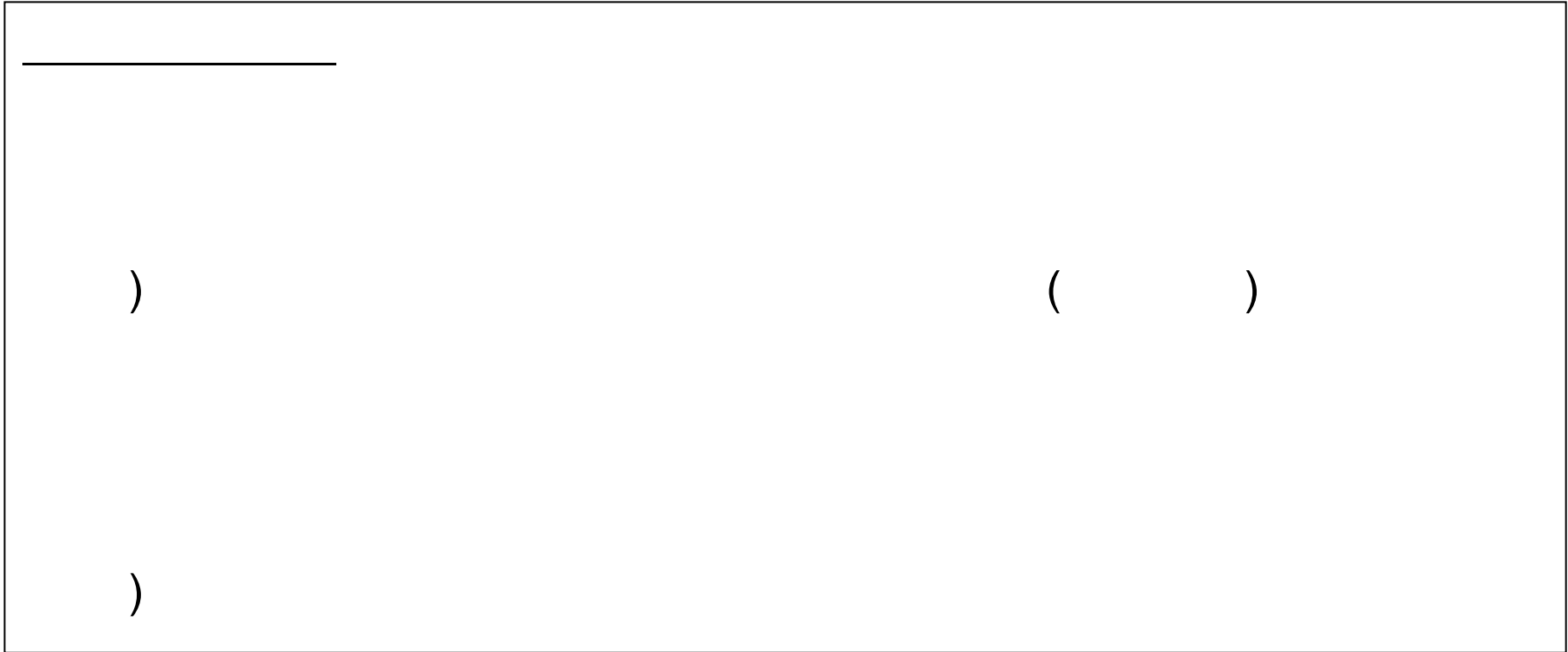

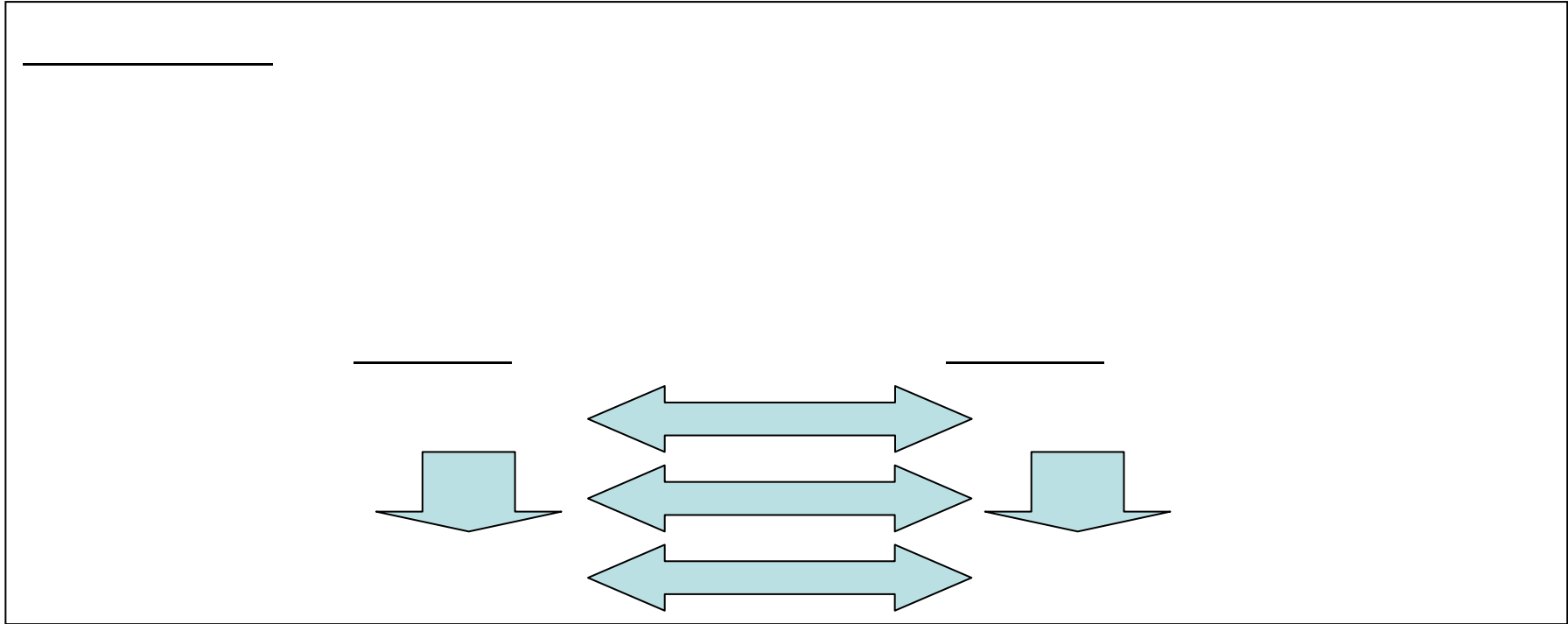

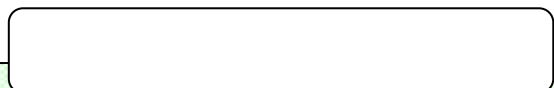
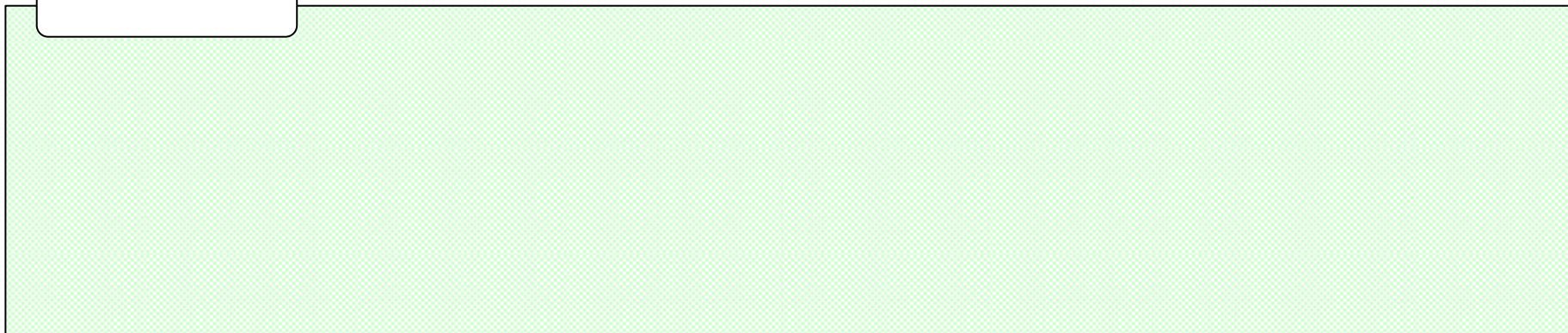

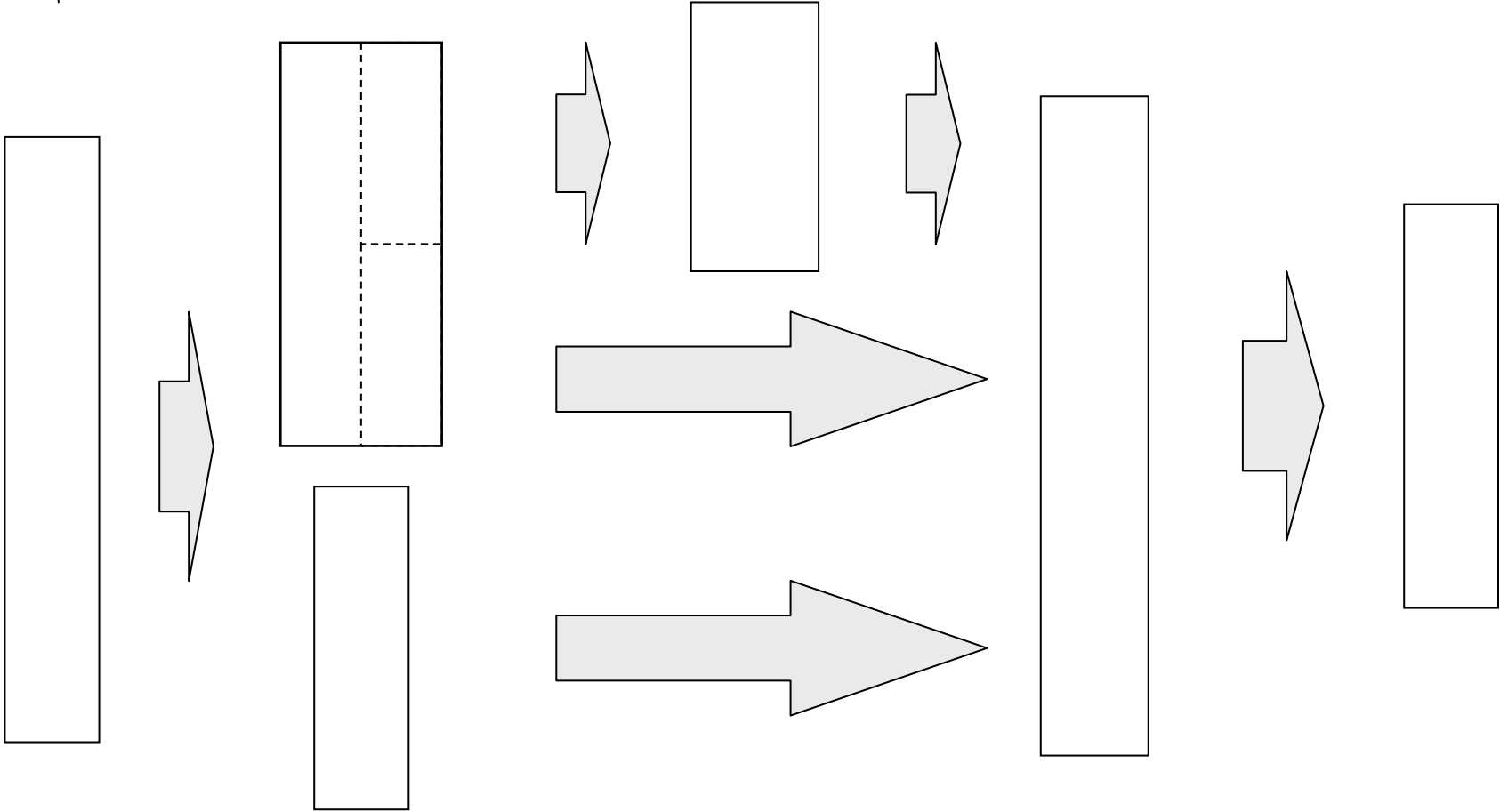
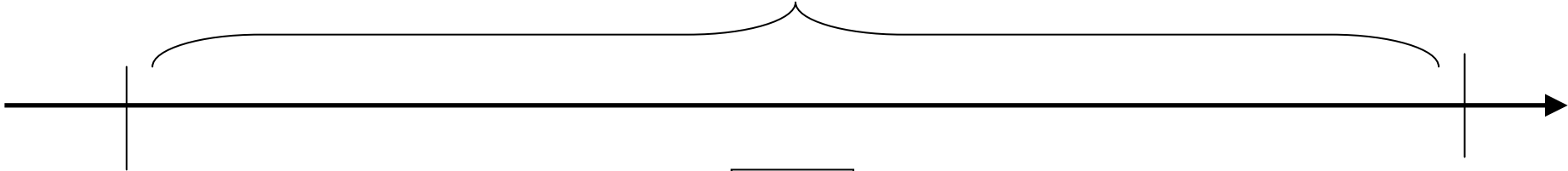
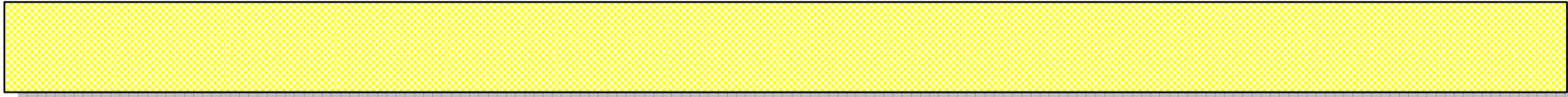



目次

()

10

4

11

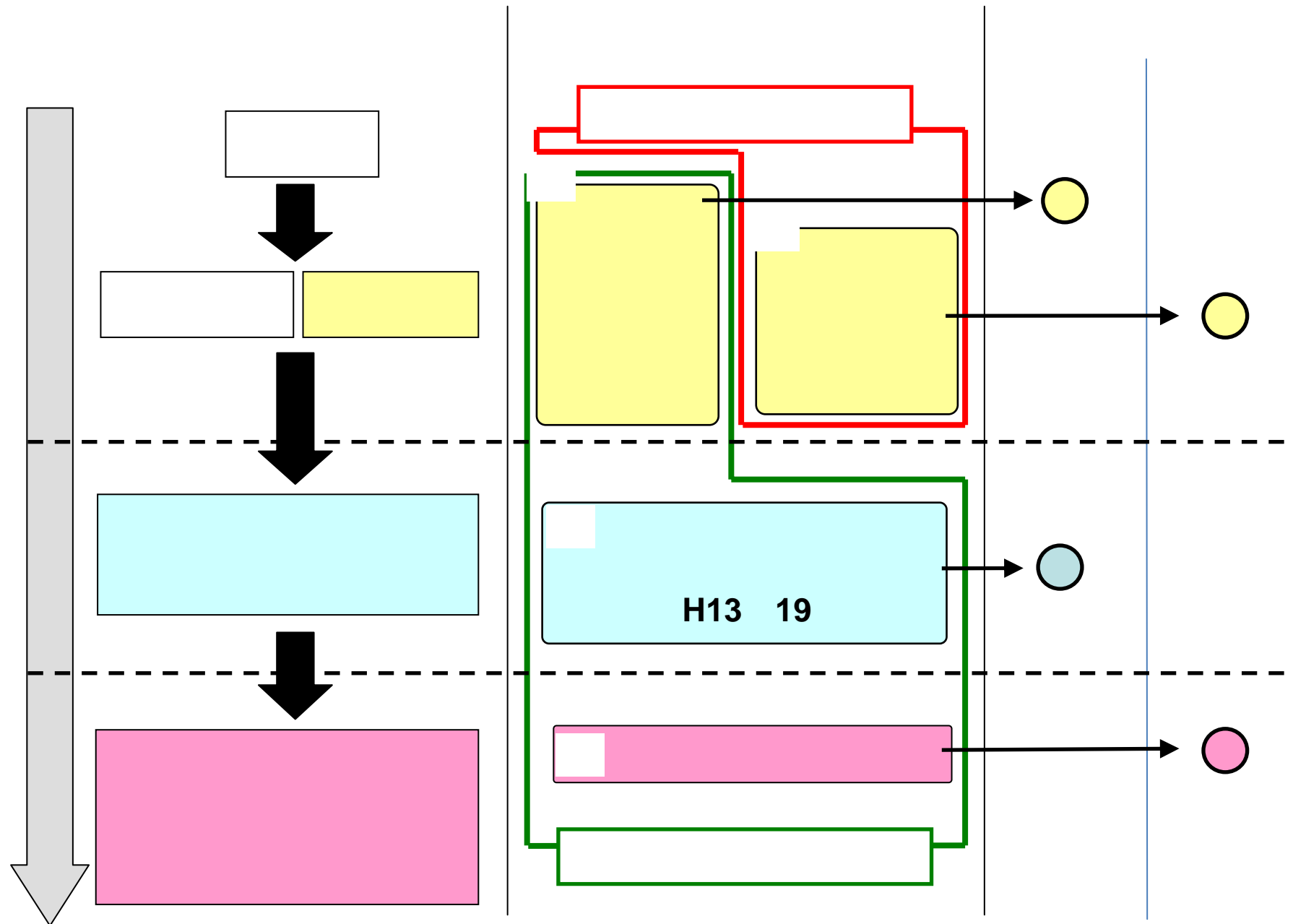

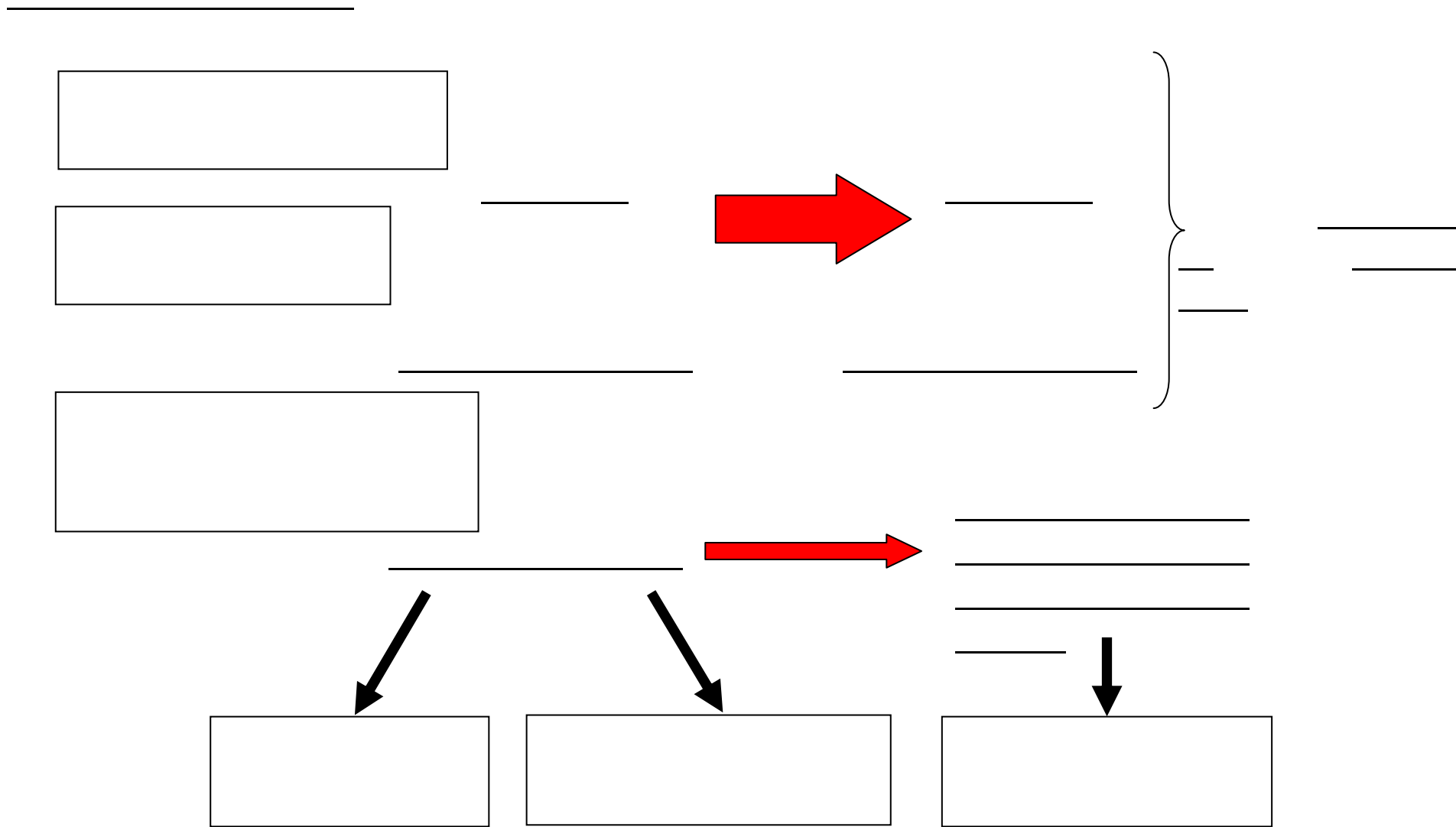

一次判定結果 : 要介護4

要介護認定等基準時間 : 106.1分

1 一次判定等

一次判定結果 : 要介護2

要介護認定等基準時間 : 57.1分

| | | | | | | | |
|------|-------|------|-------|------|------|------|-------|
| 食事 | 排泄 | 移動 | 清潔保持 | 間接 | 間接行動 | 機能訓練 | 医療関連 |
| 0.7分 | 21.3分 | 2.7分 | 16.5分 | 3.6分 | 0.4分 | 1.5分 | 10.4分 |

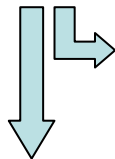
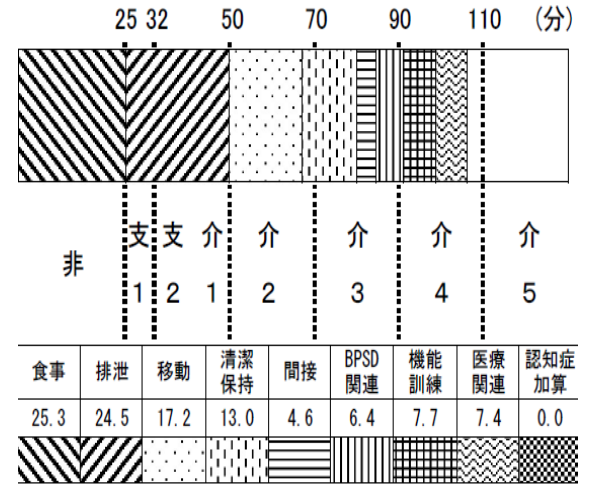

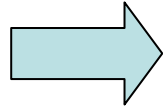

- 「独り言・独り笑い」
- 「自分勝手に行動する」
- 「話がまとまらない」
- 「集団への不応」
- 「買い物」
- 「簡単な調理」

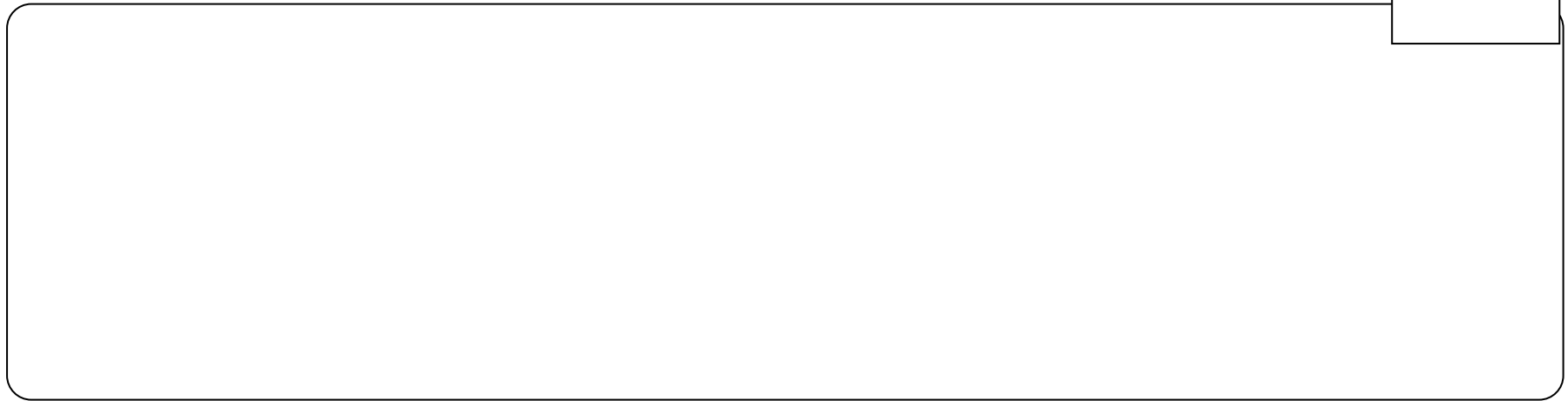
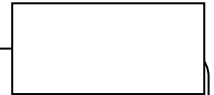
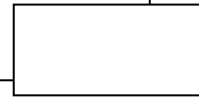

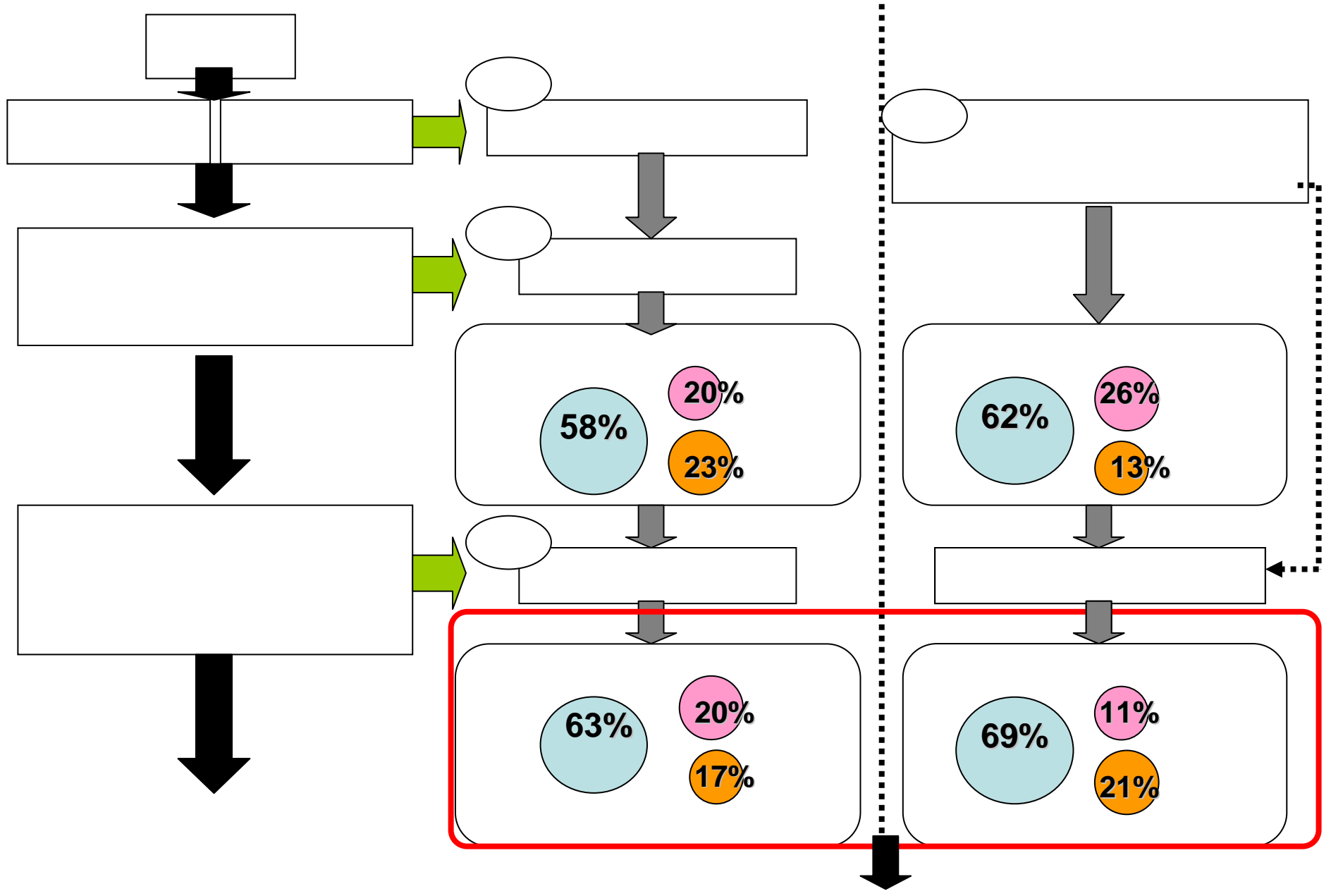

()

| | 1.5% | 19.4% | 20.6% | 19.5% | 14.4% | 11.5% | 7.3% | 6.0% |
|--|------|-------|-------|-------|-------|-------|------|------|
| | 1.7% | 21.7% | 17.2% | 21.0% | 14.3% | 10.5% | 7.9% | 5.7% |

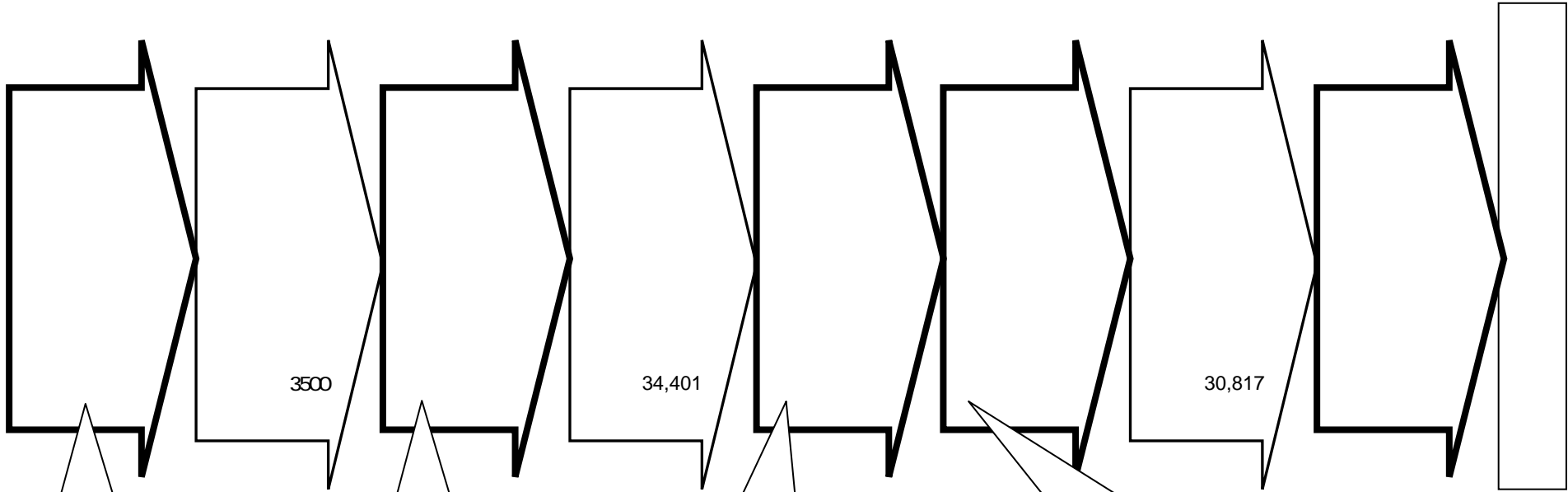

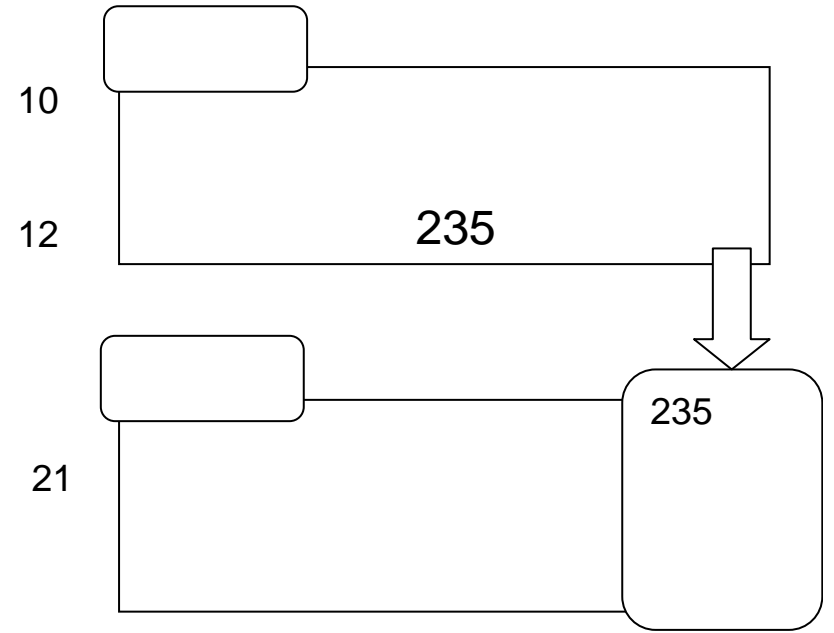
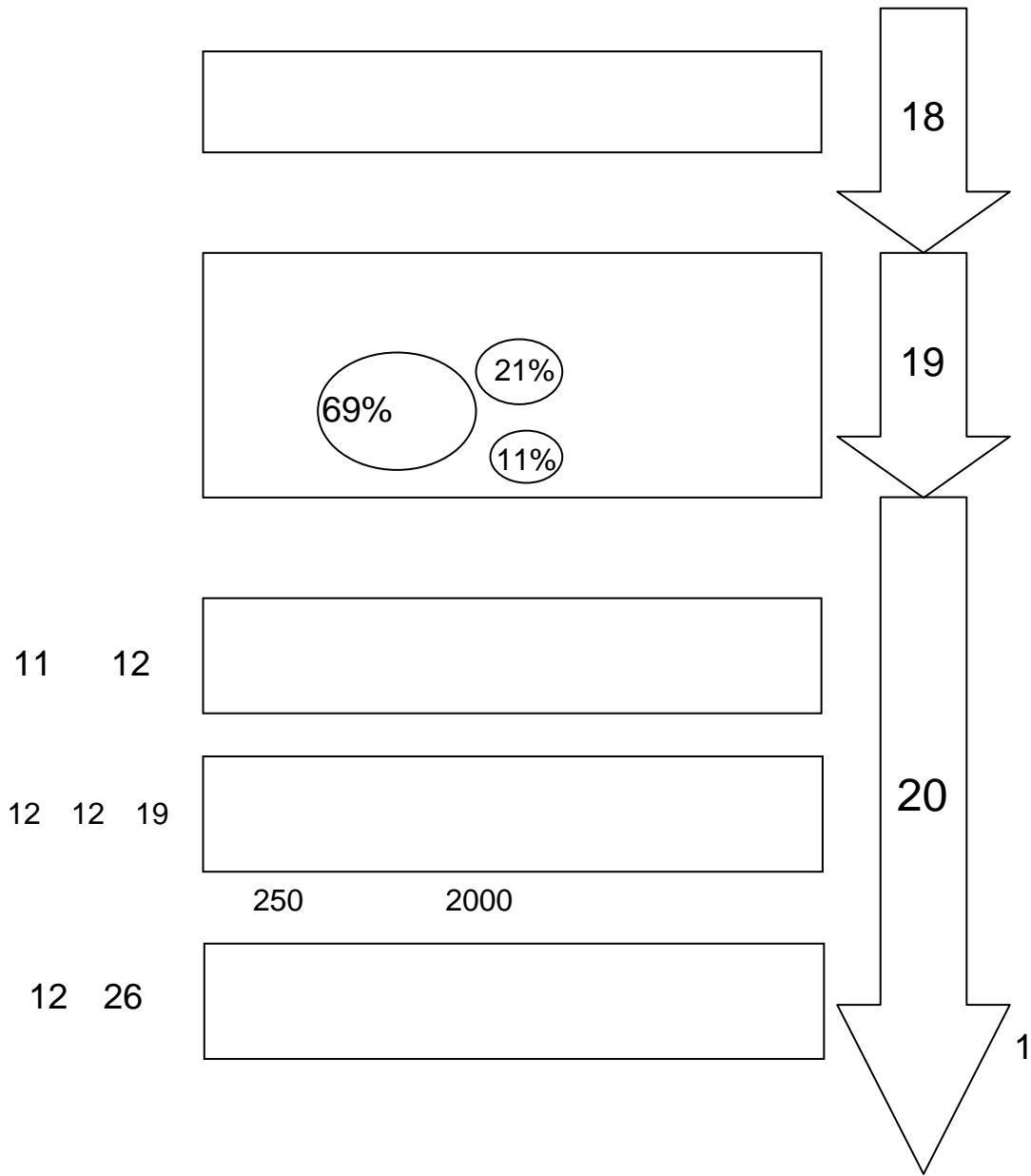

4

